

THERMORY®

STUNNING REAL WOOD CLADDING WITH DECADES OF ROT RESISTANCE

Cladding boards and shingles



Thermory real wood cladding creates a stunning, natural aesthetic that enhances any design. From the sophistication of our Benchmark Series to the rustic, bold looks of our Rebel Series, Thermory cladding is designed to achieve the look you want with the functionality you need.

Our cladding products undergo an intense thermal modification process that uses only heat and steam to give exceptional stability and durability. Innovative design features ensure tight seams for a sophisticated sightline with minimal installation time. Left untreated, Thermory cladding will slowly age to a natural platinum gray, adding a simple, timeless elegance to any project.

Thermory's painted cladding selection is a high-quality solution that makes any building stand out from the crowd. For a long-lasting finish, the thermally modified wood is coated with water-based paints that are environmentally friendly and have been tested in harsh climates.

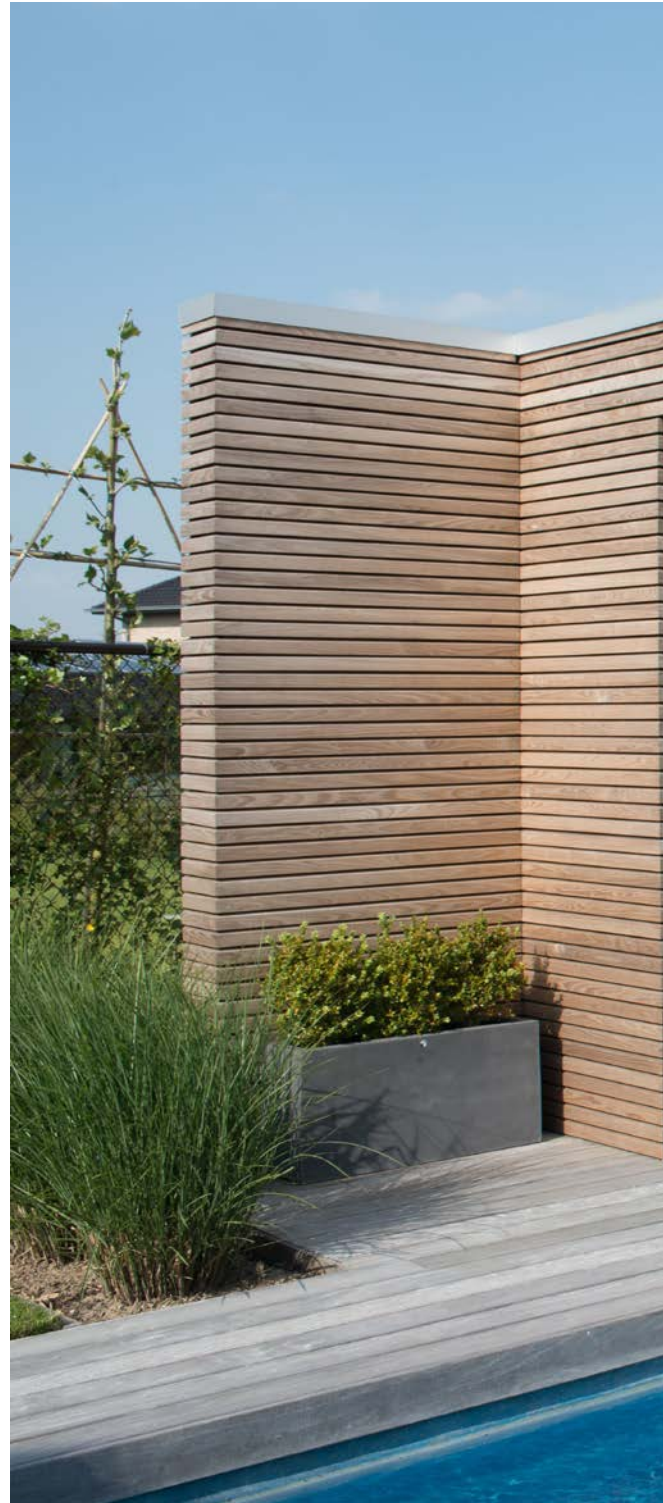



Benchmark by Thermory thermo-ash cladding, hidden installation with PaCS Clad
Distribution & Photo by Carpentier Hardwood



Benchmark by Thermory thermo-radiata pine cladding (C3)
 Jack's Point Family Home in New Zealand
 Designed by Ben Hudson architects. Photo by Sarah Rowlands

1. We are Thermory®	5	5.2 Ignite by Thermory	25
2. Thermory® Wood species for cladding	8	6. Thermory Vivid Series	28
3. Thermory Benchmark Series	10	7. Corner profile	32
3.1 Hidden installation	11	8. Roofing	32
3.1.1 Installation: PaCS®	11	9. Additional information	33
3.1.2 Installation: B1-1 clip	16	9.1 Board lengths	33
3.1.3 Installation: T-4 and T-6 clip	16	9.2 Surface textures	33
3.1.4 Installation: Tiga clip	17	9.3 Storage	33
3.1.5 Installation: Dekora clip	17	9.4 Installation	34
3.2 Installation with screws, nails or staples	17	9.5 Maintenance	35
4. Thermory Shingles	21		
5. Thermory Rebel Series	23		
5.1 Kodiak by Thermory	23		



1. We are Thermory®

Using only heat and steam, we create extremely durable and climate-resistant decking, cladding, flooring, wall paneling and sauna products that are unrivaled in both performance and sustainability compared with the usual alternatives such as plastic composites, chemically treated woods and tropical hardwoods.

Thermory wood can be found in more than 50 countries around the world; in homes and public spaces, in a variety of buildings and environments, in high humidity and extreme heat, in cold and in warmth. Our broad selection of products meets the needs of hundreds of diverse tastes and styles.

Our purchasing process is environmentally responsible, and we exercise high standards for quality and sustainability.

Our timber is carefully inspected and harvested from sustainably managed forests, never from endangered, tropical or rainforest woodland. If desired, we can offer PEFC, FSC or Nordic Swan Ecolabel-certified wood.



100% REAL WOOD PRODUCTS



QUALITY MATERIALS

An unbeatable range of wood species, profiles and finishes



INDUSTRY EXPERTS

Delivering superior quality and unrivaled beauty for over 20 years



SUSTAINABLE

Wood from sustainably managed forests with chemical-free modification





Benchmark by Thermory thermo-pine cladding (PaCS C71)
AARhus residential development in Denmark
Distributor Dølle Nordic. Designed by Bjarke Ingels Group.
Photo by Kåre Viemose

Thermory's expertise is in the process and technology of thermally modified wood

Thermal modification is a way of naturally enhancing wood. The chemical-free heat treatment makes the wood extremely durable and stable for both indoor and outdoor use, giving it a beautifully deep shade and bringing out its natural beauty.

Unlike chemical impregnation, Thermory's thermal modification enhances the wood throughout, not just the outer surface. The result is quality boards that are stable and durable in every sense.



→ **THE HEAT**

ENHANCES THE WOOD'S STRUCTURE THROUGHOUT

→ **THE STEAM**

GIVES US FULL CONTROL OVER THE PROCESS



THERMALLY MODIFIED WOOD

Naturally enhanced using only heat & steam



DIMENSIONAL STABILITY

Enhanced dimensional stability in changing weather conditions



CHEMICAL-FREE

Thermal modification process is entirely natural



DURABILITY

Improved durability and rot resistance



BETTER INSULATING QUALITIES

Reduced thermal conductivity



NON-HAZARDOUS WASTE

Safe waste handling

2. Thermory® Wood species for cladding

Thermory offers thermally modified real wood cladding products in a wide range of profiles and dimensions, produced mostly on order. This brochure aims to work as a guide and tool for searching the various wood types and profile options already available, either standard or custom made.

Contact our sales team info@thermory.com for guidance on minimum order quantities, availability, lead times and production location.

○ All Thermory exterior cladding boards undergo intense thermal modification and are durable, stable and rot-resistant without additional surface treatment.

○ Using the correct installation and supplemental maintenance techniques will result in the most beautiful and long-lasting wooden cladding.

○ Natural look from thermal modification is warm brown.

○ As with any other wood, the surface of thermally modified wood will acquire a natural silver gray colour over time. This process can take a few months to several years depending on how much UV light they are exposed to.

○ Keep in mind that wood is a natural material and so any color changes may be uneven. Each board ages in its own way, and different sides of a building's facade will also age differently depending on the sun and rain they're exposed to.

○ Thermory cladding boards can be protected with a coat of UV-resistant pigmented finish such as wax, stain, paint or mineral oil to reduce discoloration or freshen up their appearance.

○ For Thermory coated claddings, maintenance painting requirements are based on the specific product.

THERMORY THERMO-ASH

MODIFICATION LEVEL: INTENSE

HIGH-PERFORMANCE HARDWOOD THAT EXCEEDS EXPECTATIONS

Thermory's thermally modified ash products are a hardwood solution for exceptional rot-resistance and longevity combined with a clear face and rich brown color. This can offer sustainability benefits, for example by making thermo-ash a great alternative to tropical hardwood. Thermory thermo-ash has similar durability characteristics to tropical wood (class 1, 25+ years) with superior dimensional stability.



○ CLASS 1

According to CEN/TS 15083-1:2005

After installation

Unioiled wood exposed to UV light



THERMORY THERMO-PINE

THE NEW DURABILITY STANDARD FOR SOFTWOOD

The natural look of thermally modified pine is golden-brown, with distinctive knots and more resin than other woods. Thermal modification adds decades of rot resistance to this softwood without using any chemicals.

After installation



MODIFICATION LEVEL: INTENSE



CLASS 2

According to CEN/TS 15083-1:2005

Unoiled wood exposed to UV light

THERMORY THERMO-RADIATA PINE

AN ELEGANT, KNOT-FREE LOOK IN DURABLE SOFTWOOD

The natural look of thermally modified radiata pine is warm caramel brown. Each and every board is unique, with its own natural grain.

Unfinished radiata pine cladding should be oiled or painted on all four sides as well as boards ends with a UV-resistant surface-sealing oil or paint prior to outdoor installation, with the finish regularly reapplied before it wears off. You can also leave your thermo-radiata pine cladding uncoated only if it is not subject to excessive moisture, but dust and other airborne particles are more likely to adhere to the porous surface of the natural wood.

After installation



MODIFICATION LEVEL: INTENSE



CLASS 2

According to CEN/TS 15083-1:2005

Unoiled wood exposed to UV light

THERMORY THERMO-SPRUCE

DURABLE SOFTWOOD WITH RUSTIC CHARM

Spruce, sourced in Scandinavia and thermally modified by Thermory, offers a softwood solution with exceptional rot resistance and longevity combined with rustic knots and a naturally light golden-brown color. For reversible C4 and D4 profiles, where possible we recommend installing thermo-spruce with the heartwood hidden from direct sunlight.

After installation



MODIFICATION LEVEL: INTENSE



CLASS 1

According to CEN/TS 15083-1:2005

Unoiled wood exposed to UV light

3. Thermory Benchmark Series

BEAUTIFULLY SIMPLE, REMARKABLY DURABLE REAL WOOD PRODUCTS

Our Benchmark Series products define refined sophistication with simple solutions. Our innovative process results in products that are highly rot-resistant and environmentally friendly without sacrificing strength or pliability; products with extraordinary longevity.

Sophisticated. Simple. Unrivaled.



DURABILITY

Highest available durability class for real wood



EASY INSTALLATION

Innovative and simple fixing methods



STABILITY

Dimensionally stable in changing weather conditions



LOW MAINTENANCE

Oil it or not, the choice is yours

Depending on the profile, Benchmark cladding can be installed with screws, clips or PaCS – the world’s simplest screwless system.

On request are available different surface finishings: brushing, embossing and for thermo-pine cladding also roughening.

Most profiles can be ordered with an end-matching solution, meaning that the joints don’t have to rest on joists, dramatically reducing wastage, labor costs and installation time.

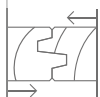

END-MATCHING AVAILABLE

Put joints wherever you want



BRUSHING

Highlights the wood’s natural grain



ROUGHENING FOR THERMO-PINE

Adds distinctive rustic appearance



EMBOSSING

Creates beautiful structure without changing wood properties



Benchmark by Thermory thermo-ash cladding Private house in Toronto, Canada

3.1 HIDDEN INSTALLATION

We offer various hidden installation accessories to create a beautiful screw-free cladding surface. All of these fixings also create sufficient air gaps between the boards to prevent moisture damage.



3.1.1 INSTALLATION: PaCS®

CLADDING INSTALLATION WITH JUST A PRESS, AND CLICK!

PaCS® product range combines high-quality Thermory thermowood with unique Grad® installation system. It is a hidden fastening solution designed for a quick and easy installation. Thermory PaCS consists of specially profiled Thermory boards with grooves on the underside to perfectly fit the Grad clips: Grad single clips, PaCS CLAD thermopine battens with premounted Grad clips or PACS Alu Rail 56 aluminium battens with premounted Grad clips.

As a result, there are no visible screw heads – the boards are simply pressed and clicked into place.



The boards click into place when depressed and it's done.

- On request: end-matching, roughening or brushing.
- PaCS products are also available as decking.
- Standard selection available by pack. For the rest of products minimum order quantity applies.



HIDDEN FIXING
No visible screws



EASY INSTALLATION
Just press and click



Benchmark by Thermory thermo-radiata pine C4J, PaCS Alu Rail Start



Benchmark by Thermory thermo-ash cladding Maidla Nature Villa in Estonia
Designed by Mari Hunt, b2i0 Architects
Photo by Elvo Jakobson

○ Standard items

PROFILE	WOOD	MODIFICATIONS	THICKNESS (MM)	WIDTH (MM)	COVERING WIDTH (MM)	PCS IN BUNDLE	
C4J 	Thermo-ash	○	20	52	57	8	
			26	52	57	6	
	Thermo-pine		42	42	57	4	
			20	42	57	8	
Thermo-radiata pine	Thermo-pine	Intense thermo	20	65	64* 71**	8	
			42	42	57	4	
20	65		64* 71**	8			
20	134		142	4			
Thermo-radiata pine	Thermo-radiata pine	Intense thermo	20	134	142	4	
			20	134	142	4	
C7J	Thermo-ash		○	20	52	57	8
				26	52	57	6
	Thermo-pine	20		72	80	4	
		20		65	64* 71**	8	
Thermo-radiata pine	Thermo-radiata pine	Intense thermo	26	65	64* 71**	6	
			20	65	64* 71**	8	
Thermo-hickory	Thermo-hickory		20	52	57	8	
			20	72	80	4	
G-C7J	Thermo-pine	Intense thermo, brushing	20	138	142	4	
			20	138	142	4	
C23J	Thermo-ash		○	20	150	143	4
				20	186	178	4
C44J	Thermo-pine	20		134	142	4	
		20		134	142	4	
G-C77J	Thermo-pine	Intense thermo	20	138	142	4	
			20	138	142	4	
D45J	Thermo-ash		21	118	118	4	
			26	118	118	3	

* PaCS CLAD 65-0 or PaCS Alu Rail Start 65-0

** PaCS CLAD 65 or PaCS Alu Rail Start 65



C4J Benchmark by Thermory thermo-ash



C4J Benchmark by Thermory thermo-pine



C23J Benchmark by Thermory thermo-ash



C4J Benchmark by Thermory thermo-radiata pine

All pictures are for illustrative purposes only. Actual products may differ in appearance as wood is a natural material - each piece is unique, just like us.

PaCS® CLAD consists of Thermory thermo-pine batten with pre-mounted Grad® single clips.

SIZE: 26 x 67 x 2000 mm

BOARD HEIGHT FROM SUBSTRUCTURE:
26 + 5 = 31 mm

REQUIRED NUMBER OF PaCS CLAD:
1 pc per square meter



PaCS® Alu Rail Start is an aluminum rail with factory-positioned Grad clips. PaCS Alu Rail Start come with an option to remove and replace any board at any time while keeping the existing boards and clips reusable.

SIZE:

ALU RAIL START 118 12 x 47 x 1984 mm

ALU RAIL START 150 12 x 47 x 1876 mm

BOARD HEIGHT FROM SUBSTRUCTURE:
12 + 6 = 18 mm

REQUIRED NUMBER OF PaCS ALU RAIL START:
1 pc per square meter

Available special keys for board removal.



PaCS® Alu Rail 56 is a load-bearing aluminum joist with pre-mounted Grad clips. Predominantly used for decking. Available special keys for board removal.

SIZE: 56 x 63,6 x 1984 mm

BOARD HEIGHT FROM SUBSTRUCTURE:
rail 56 mm + clips 6 = 62 mm

REQUIRED NUMBER OF ALU RAIL 56 JOIST:
1 pcs per one square meter



CHOOSE YOUR PACS CLAD OR PaCS ALU RAIL BASED ON PROFILE WIDTH:

FIXING SYSTEM PRODUCT NAME			CLADDING BOARD WIDTH, MM	PROFILE WITH GRAD GROOVES	PRE-MOUNTED GRAD SINGLE CLIPS PER CLAD OR ALU RAIL	BOARDS PER BATTEN	BOARD STEP, MM
PaCS CLAD	PaCS ALU RAIL START	PaCS ALU RAIL 56					
CLAD52	Alu Rail Start 52		42	C4J	35	35	57
			52	C4J, C7J	35	35	57
			65	C4J, C7J	28	28	71.4
CLAD65	Alu Rail Start 65		134	C4J, C44J	28	14	142.8
			138	G-C7J, G-C77J	28	14	142.8
CLAD65-0	Alu Rail Start 65-0		65	C7J	31	31	64.5
CLAD72	Alu Rail Start 72		72	C7J	25	25	80
	Alu Rail Start 118	Alu Rail 56	118	D45J	32	16	124
CLAD150	Alu Rail Start 150		150	C23J	28 (Alu Rail 26)	14 (Alu Rail 13)	144
CLAD185*			186	C23J	26	13	178

* Pre-mounted Grad clips on plywood. Contact our sales team info@thermory.com for product specifications.

Grad single clip can be used with all PaCS profiles. It is the most suitable fastener in cases where a custom gap between boards is desired. The tested tearing strength of Grad single clip is 75–125 kg.



REQUIRED NUMBER OF GRAD SINGLE CLIPS:
2 pcs per running meter of boards with one groove

CLIPS PER PACK: 900 pcs

THE COUNTERSINK SCREW SIZE NEEDED FOR GRAD SINGLE CLIPS: 4 x 25 mm

Thermory TopLink spacers



For PaCS® installation procedures and requirements please follow **Thermory Cladding Installation Guide**. See also installation videos on Thermory Youtube channel.

PLEASE NOTE: PaCS Alu Rail Start and PaCS Alu Rail PR56 cannot be joined together lengthwise by simply placing one rail in direct contact with another! A profile-specific top link spacer must be used to maintain the correct distance between clips from one rail to the next.

All pictures are for illustrative purposes only. Actual products may differ in appearance as wood is a natural material - each piece is unique, just like us.

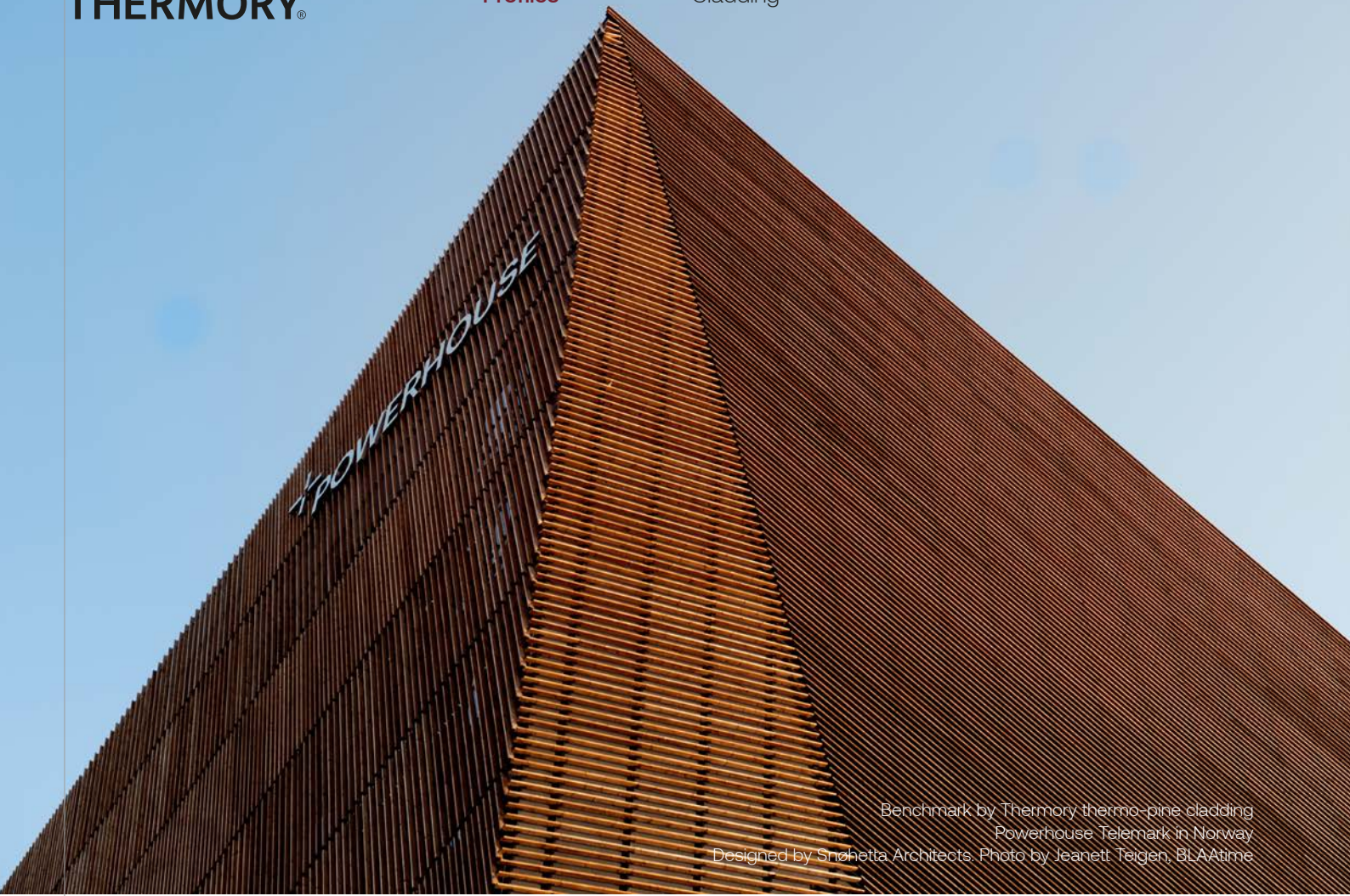

Benchmark by Thermory thermo-pine cladding
Powerhouse Telemark in Norway
Designed by Snøhetta Architects. Photo by Jeanett Teigen, BLAAtime







3.1.2 INSTALLATION: B1-1 CLIP

Thermory stainless steel clip “B1-1” creates cladding surface with no visible screws

screws and it leaves a distance of 4 mm between the boards.



HIDDEN FIXING
No visible screws

PROFILE
C6 
C9 

WOOD	MODIFICATIONS	THICKNESS (MM)	WIDTH (MM)	COVERING WIDTH (MM)	PCS IN BUNDLE
Thermo-ash	Intense thermo	20	132	121	4
Thermo-pine		20	155	144	4
Thermo-radiata pine		20	140	129	4
Thermo-ash		20	95	98	4
		20	112	115	4



C6 Benchmark by Thermory thermo-ash

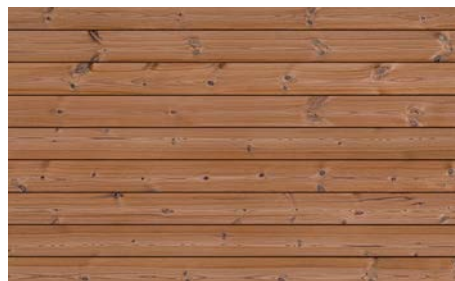

C6 Benchmark by Thermory thermo-pine



C6 Benchmark by Thermory thermo-radiata pine



REQUIRED NUMBER OF B1-1 CLIPS:
2 pcs per running meter if battens are installed every 600 mm

Use 4 x 40-mm stainless-steel screws to fix the clips to the batten; we recommend 2 screws per clip.



CLIPS PER PACK: 100 pcs.

3.1.3 INSTALLATION: T-4 AND T-6 CLIP

Thermory black-coated stainless steel clips “T-4” and “T-6” both create cladding surface with no visible screws. Clip T-4 leaves a 4 mm gap between the boards and clip T-6 a 6 mm gap between the boards.

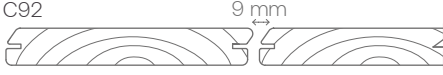

HIDDEN FIXING
No visible screws

PROFILE
T-4 clip D4 sg2 
T-6 clip C92 
D4 sg2 

WOOD	MODIFICATIONS	THICKNESS (MM)	WIDTH (MM)	COVERING WIDTH (MM)	PCS IN BUNDLE
Thermo-ash	Intense thermo	20	95	97	4
		20	112	114	4
Thermo-ash	Intense thermo	20	132	135	4
Thermo-pine		20	140	143	4
Thermo-ash		20	132	135	4
		20	150	153	4

○ Standard items



REQUIRED NUMBER OF T-4 AND T-6 CLIPS:
2 pcs per running meter if battens are installed every 600 mm

CLIPS PER PACKAGING: 500 pcs, including screws and drill bit.

3.1.4 INSTALLATION: TIGA CLIP



HIDDEN FIXING
No visible screws

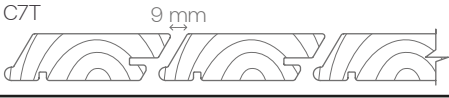

BENCHMARK
by THERMORY®

PROFILE	WOOD	MODIFICATIONS	THICKNESS (MM)	WIDTH (MM)	COVERING WIDTH (MM)	PCS IN BUNDLE
C7T 	Thermo-pine	Intense thermo	26	90	84	3

3.1.5 INSTALLATION: DEKORA CLIP



HIDDEN FIXING
No visible screws



BENCHMARK
by THERMORY®

The facade connector Dekora guarantees a simple, fast and safe installation process.

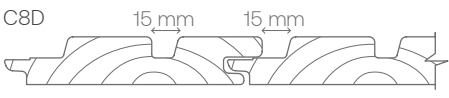
PROFILE	WOOD	MODIFICATIONS	THICKNESS (MM)	WIDTH (MM)	COVERING WIDTH (MM)	PCS IN BUNDLE
C8D 	Thermo-pine	Intense thermo	26	140	121 * 119 **	3

* Installation: Dekora clip
** Installation: Screws, nails or staples

Dekora clip



REQUIRED NUMBER OF DEKORA CLIPS:
2 pcs per running meter if battens are installed every 600 mm

CLIPS PER PACKAGING: 100 pcs, including stainless steel screws 4.5 x 34 mm

3.2 INSTALLATION WITH SCREWS, NAILS OR STAPLES



BENCHMARK
by THERMORY®

Fix Benchmark thermo-ash with stainless steel screws (pilot holes should be predrilled).

cladding can be fixed with stainless steel self-tapping screws, nails or staples.





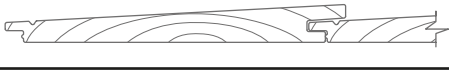
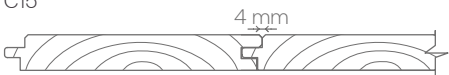

Standard selection available by pack. For the rest of products minimum order quantity applies.

Thermory Benchmark thermo-pine, thermo-spruce and thermoradiata pine

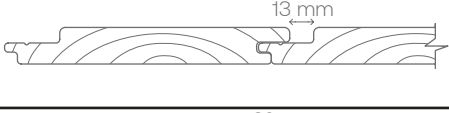
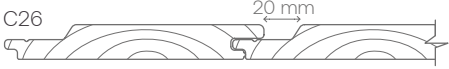
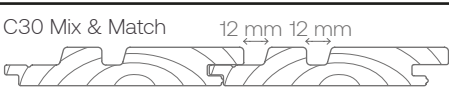
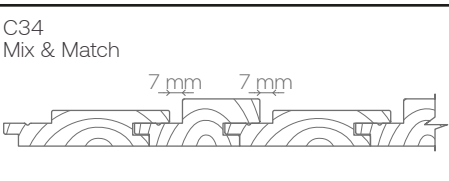
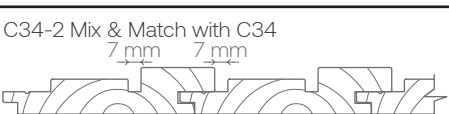
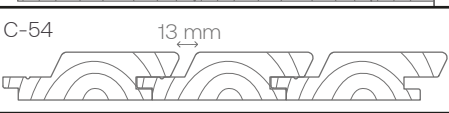
On request: end-matching, roughening or brushing.

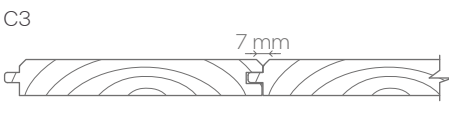
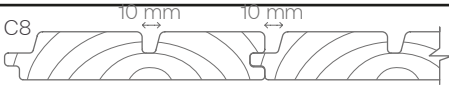
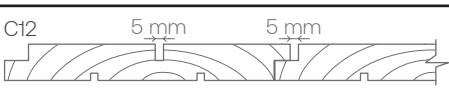
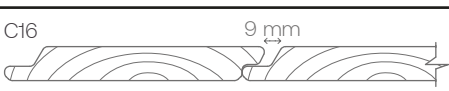
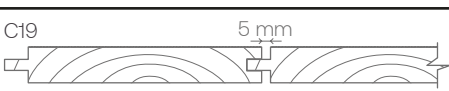
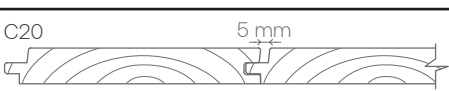
○ Standard items

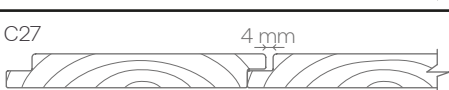
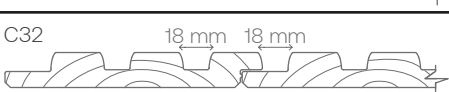
PROFILE	WOOD	MODIFICATIONS	THICKNESS (MM)	WIDTH (MM)	COVERING WIDTH (MM)	PCS IN BUNDLE
HIDDEN FIXING						
C11 	Thermo-pine	Intense thermo, brushing	26	140	132	4
C11-S 	Thermo-pine		21/12	140	120	4
C15 	Thermo-spruce	Intense thermo	○ 21/12	185	165	4
	Thermo-spruce	Intense thermo, brushing	○ 20	140	129	4
			○ 20	186	175	4
			○ 20	211	200	4

PROFILE	WOOD	MODIFICATIONS	THICKNESS (MM)	WIDTH (MM)	COVERING WIDTH (MM)	PCS IN BUNDLE	
C25 	Thermo-ash	Intense thermo	20	155	138	4	
	Thermo-pine		20	140	122	4	
	Thermo-radiata pine		20	138	121	4	
C26 	Thermo-spruce		19	141	125	4	
	Thermo-spruce		19	186	169	4	
C30 Mix & Match 	Thermo-pine		20	92	75	4	
	Thermo-pine		20	118	101	4	
C34 Mix & Match 	Thermo-pine		20	90	71	4	
	Thermo-pine		20	140	121	4	
	Thermo-pine		20	115	96	4	
	Thermo-pine		26	68	49	6	
	Thermo-pine		26	115	96	3	
C34-2 Mix & Match with C34 	Thermo-pine		42	68	49	4	
	Thermo-pine		26	115	96	4	
C-54 	Thermo-ash	26	95	73	3		
	Thermo-pine	26	92	70	3		
VISIBLE FIXING							
C1 	Thermo-pine	Intense thermo	20	115	107	4	
	Thermo-radiata pine		20	140	131	4	
C2-R4 	Thermo-spruce		20	115	107	4	
	Thermo-spruce		20	138	130	4	
C3 	Thermo-pine	Intense thermo, Fine sawn	12/26	190	175	4	
	Thermo-radiata pine		20	115	107	4	
	Thermo-radiata pine		20	140	131	4	
	Thermo-radiata pine		20	115	107	4	
C8 	Thermo-pine		20	138	130	4	
	Thermo-pine		26	140	132	3	
C12 	Thermo-ash		Intense thermo	20	155	147	4
C16 	Thermo-spruce		19	141	129	4	
C19 	Thermo-pine		Intense thermo, roughened	20	140	131	4
C20 	Thermo-ash		20	150	142	4	
	Thermo-pine		20	140	131	4	
C24 	Thermo-spruce		20	140	131	4	
C27 	Thermo-spruce		Intense thermo	19	141	131	4
C32 	Thermo-pine		20	140	129	4	
CAR3 	Thermo-radiata pine	20	138	130	4		

PROFILE	WOOD	MODIFICATIONS	THICKNESS (MM)	WIDTH (MM)	COVERING WIDTH (MM)	PCS IN BUNDLE	
CAR8 	Thermo-ash	Intense thermo	26	130	122	3	
	Thermo-pine		26	130	122	3	
CAR10 	Thermo-spruce		26	140	131	3	
	Thermo-ash		20	155	146	4	
CAR12 	Thermo-ash		26	65	58	6	
	D43 		Thermo-ash	20	92	77	4
UYS10 Mix & Match 			Thermo-pine	20	115	100	4
			Thermo-pine	20	140	124	4
			Thermo-pine	26	92	77	3
			Thermo-pine	42	67	52	4
BOARDS AND BATTENS C7 	Thermo-ash		20	52	52	8	
	Thermo-pine		20	72	72	4	
			26	65	65	6	
			26	68	68	6	
	C7-15R15 	Thermo-pine	26	92	95	3	
		C4 	Thermo-ash	20	52	52	8
	Thermo-pine		20	72	72	4	
			20	115	115	4	
			20	140	140	4	
	D4 	Thermo-radiata pine	20	185	185	4	
		Thermo-ash	20	95	95	4	
			20	112	112	4	
20			132	132	4		
20			150	150	4		
20			190	190	4		
26			90	90	3		
26			115	115	3		
26			130	130	3		
26			145	145	3		
26			160	160	3		
42			42	42	4		
42			90	90	2		
32			138	138	2		
42			135	135	2		
Thermo-pine			26	68	68	6	
	42	42	42	4			
	42	68	68	4			
	42	90	90	2			
	42	140	140	2			
	42	68	68	2			
C42 	Thermo-pine	42/28	42	42	4		

For installation procedures and requirements please follow **Thermory Cladding Installation Guide**. See also installation videos on Thermory Youtube channel.
 All pictures are for illustrative purposes only. Actual products may differ in appearance as wood is a natural material - each piece is unique, just like us.



Shingles by Thermory thermo-ash,
Benchmark by Thermory thermo-ash cladding
Schoolhouse in Trollhättan, Sweden
Designed by Contekton Arkitekter Fyrstad AB.
Photo by Devis Bionaz.

4. Thermory Shingles



Add texture to your interior or exterior walls.

Shingles by Thermory, with a resawn surface, are a trendy way to add texture to your interior or exterior walls. The intense thermal modification increases dimensional stability and durability while bringing out the natural beauty of wood. Like all Thermory products, the shingles will naturally gray over time, bringing a uniquely elegant tone to your design.

Shingles by Thermory are available as individual shingles (profile: S1) and as shingle panels (profiles: S2-BBME, S2-BBMS).

 Suitable for both exterior and interior.

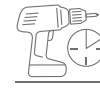

EASY INSTALLATION
Innovative solution saves you a whole lot of time

PRODUCT	MODIFICATIONS	WOOD	THICKNESS (MM)	WIDTH (MM)	COVERING WIDTH (MM)	LENGTHS (MM)
INSTALLATION: staples						
Individual shingles S1, even	Intense thermo	Thermo-ash	4/10	80-150		350
INSTALLATION: screws or nails						
Shingle panel S2-BBME, even	Intense thermo	Thermo-ash	24*	340*	239	1250
Shingle panel S2-BBMS, staggered	Intense thermo	Thermo-ash	24*	340*	239	1250

*panel measures



Shingle panel S2-BBME



Shingle panel S2-BBMS



 Profiles S2-BBME, S2-BBMS is a combination of Thermory thermo-ash shingles on Baltic Birch Plywood with vapor permeable roof membrane. It offers a superior panel solution for an eye-catching result with the most common and simple installation practices. The shingle panels are tongue and groove fitted and can be nailed onto joists or flat surfaces with ease. This reduces installation time considerably, provides strong wind resistance and creates a water barrier for a longlasting quality product. Available for both designs: even and staggered.

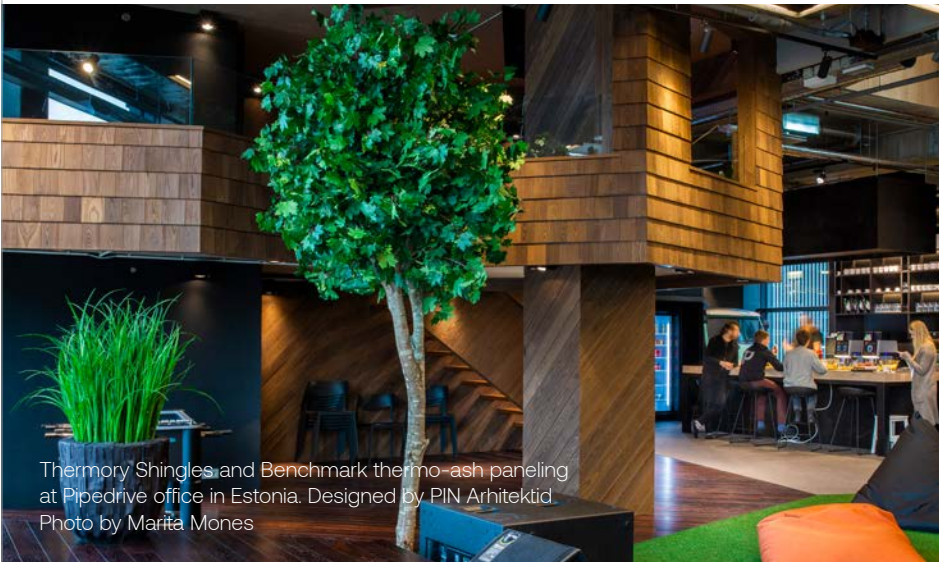

Thermory Shingles and Benchmark thermo-ash paneling at Pipedrive office in Estonia. Designed by PIN Arhitektid. Photo by Marita Mones

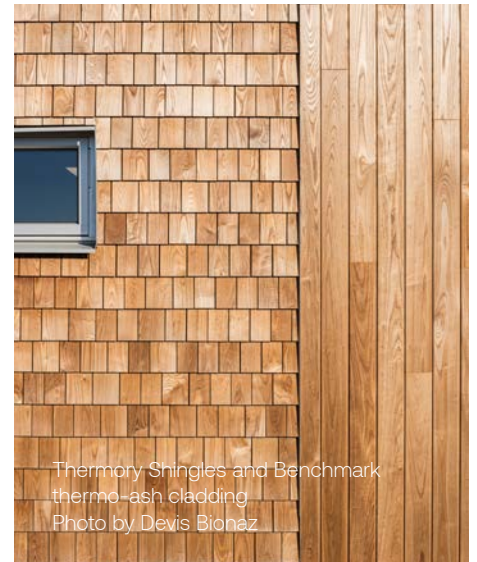

Thermory Shingles and Benchmark thermo-ash cladding. Photo by Devis Bionaz

For installation procedures and requirements please follow [Thermory Shingles Installation Guide](#).

All pictures are for illustrative purposes only. Actual products may differ in appearance as wood is a natural material - each piece is unique, just like us.



Kodiak by Thermory thermo-spruce cladding



Kodiak by Thermory thermo-spruce cladding

5. Thermory Rebel Series

Let your imagination loose and choose a solution from our Rebel Series that brings your unique character into your home or office.

5.1 KODIAK BY THERMORY



A little rugged. A little wild. A lot of board.

Kodiak by Thermory gives your project the bold allure of the backwoods. Knotted spruce boards retain their natural appeal, while their extra wide

size allows for faster installation. The brushed texture adds ruggedness without sacrificing the refined look.

- Suitable for both exterior and interior.
- “Kodiak by Thermory” also available as decking.

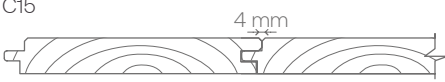
PROFILE	WOOD SPECIES	MODIFICATIONS	THICKNESS (MM)	WIDTH (MM)	COVERING WIDTH (MM)	PCS IN BUNDLE
HIDDEN INSTALLATION: screws, nails or staples						
C15 	Thermo-spruce	Intense thermo, rustic, brushing	20	186	175	4
			20	211	200	4



EXTRA WIDE BOARDS
Extra wide size for bold looks and faster installation



STABILITY
Dimensionally stable due to a significant reduction in equilibrium moisture content



RUSTIC BRUSHED LOOKS
Brushing highlights the wood’s natural grain





Ignite by Thermory cladding



Ignite by Thermory thermo-spruce cladding (Ignite 5)
New American Home in USA
Photo by Jeffrey A. Davis

5.2 IGNITE BY THERMORY



Ancient tradition, modern performance.

Ignite by Thermory offers the look of charred wood with additional durability, stability and reliability from thermal modification. The signature dragon-scale pattern of Ignite cladding is created by embossing and painting the wood. As our process is completely flame-free the product will not stain nor crumble during or after installation.



Suitable for both exterior and interior.



EASY INSTALLATION

Pre-painted and ready to install – saves costs



NO MESSY RESIDUE

Touch worry-free as the surface does not stain



EXCEPTIONAL SURFACE DURABILITY

Enjoy the charred looks for longer



EMBOSSED

Dragon Scale pattern gives a beautiful structure to the wood

○ Standard items

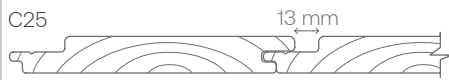
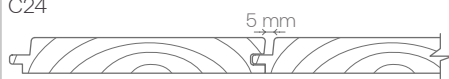
PROFILE	WOOD SPECIES	MODIFICATIONS	FINISHING	THICKNESS (MM)	WIDTH (MM)	COVERING WIDTH (MM)	PCS IN BUNDLE
HIDDEN INSTALLATION: screws, nails or staples							
C15 	Thermo-spruce	Intense thermo, embossing (Dragon Scale)	Ignite5, Ignite7 ○	20	140	131	4
C25 	Thermo-radiata pine			20	186	175	4
				20	138	121	4
				20	185	168	4
INSTALLATION: black screws							
C24 	Thermo-spruce	Intense thermo, embossing (Dragon Scale)	Ignite5, Ignite7 ○	20	140	131	4

PLEASE NOTE: Panel ends and any dents must be painted.



IGNITE 5 SEMI-TRANSLUCENT BLACK. Maintenance painting: every 5 years with water-based semi-translucent black paint.



IGNITE 7 OPAQUE BLACK. Maintenance painting: every 7 years with water-based opaque (full coating) RAL9005 paint.

For installation procedures and requirements please follow [Thermory Cladding Installation Guide](#). For maintenance requirements please follow [Thermory Cladding Maintenance Guide](#). See also installation videos on Thermory Youtube channel.



Vivid by Thermory thermo-spruce cladding (D4 / Channelsiding), color Black.
Private house in Netherlands.
Distribution & Photo by InterFaca



Vivid by Thermory thermo-spruce cladding
Distribution & Photo by InterFaca

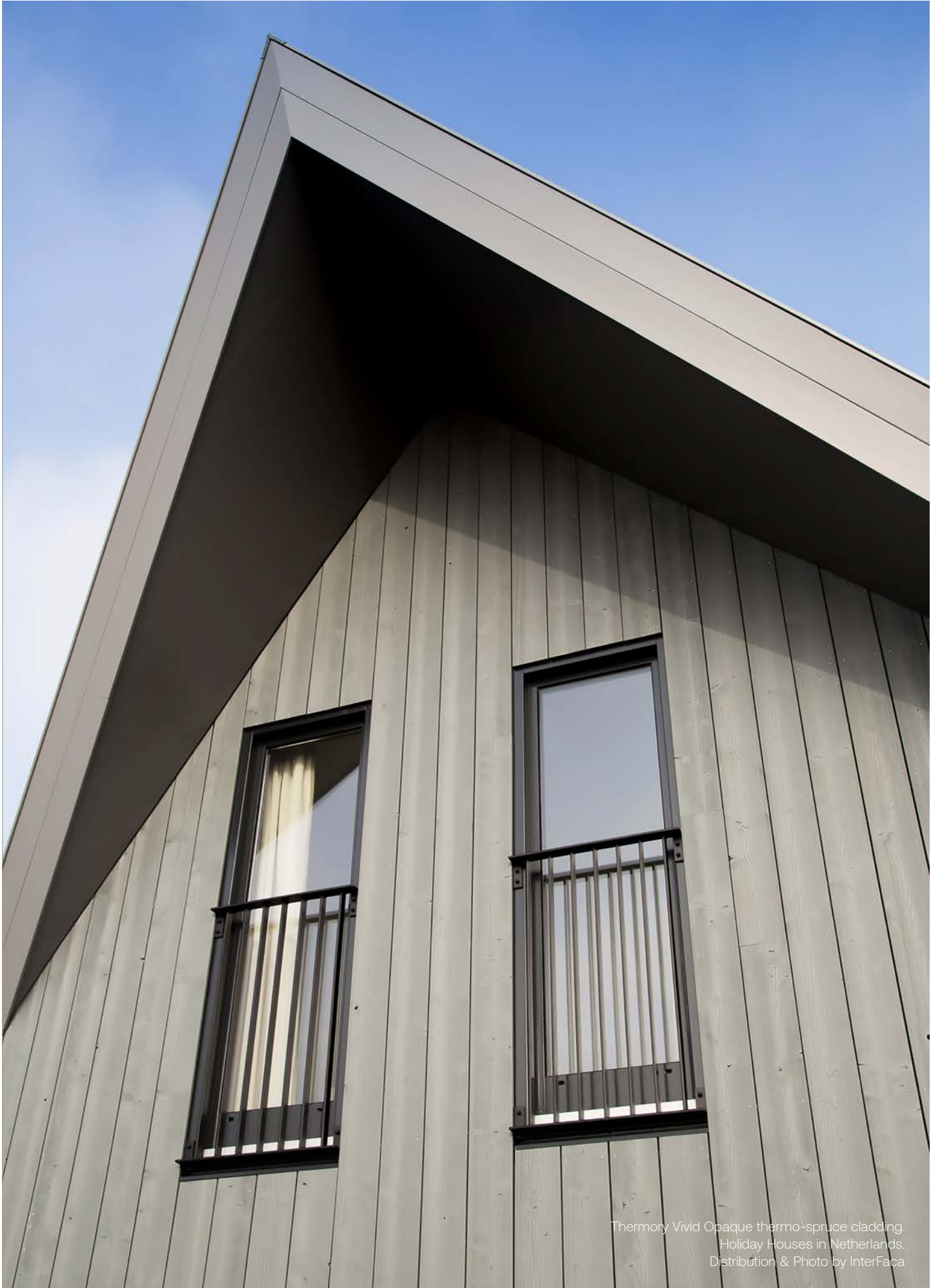

Thermory Vivid Opaque thermo-spruce cladding.
Holiday Houses in Netherlands.
Distribution & Photo by InterFaca

6. Thermory Vivid Series



Excellent resistance against decay and diverse weather conditions.

VIVID by THERMORY coated cladding selection is a high-quality solution that makes any building stand out from the crowd. Thermory cladding products undergo an intense thermal modification process to give exceptional stability

and durability. The boards are brushed to enhance their natural pattern. For a long-lasting finish, the wood is then coated with water-based paints that are environmentally friendly and have been tested in the harshest climates.



BRUSHED AND PAINTED SURFACE

Enhanced natural pattern with long-lasting finish



ECO-FRIENDLY

Wood from sustainable forests with water-based coatings



EASY INSTALLATION

Pre-painted and ready to install – saves costs

For all Thermory Vivid series installation procedures and requirements please follow **Thermory Cladding Installation Guide**. For maintenance

requirement please follow **Thermory Cladding Maintenance Guide**. See also installation videos on Thermory Youtube Channel.

VIVID OPAQUE



Go wild with your walls with vivid cladding.

Vivid Opaque cladding boards are thermally modified, brushed and coated with weatherproof paint. They come ready to install and have excellent resistance against decay and various weather conditions.



Vivid Opaque 10 has 80 my (micron) dry paint layers and has a 10-year service lifetime.



EXCEPTIONAL COLOR DURABILITY

Longer color lifetime due to high dimensional stability



LOW MAINTENANCE

Improved service time thanks to the benefits of thermal modification

VIVID OPAQUE IS AVAILABLE IN COLOR OPTIONS:



RAL9005 Black



RAL 1019 Gray Beige



RAL 7045 Mid Gray



RAL 7016 Antracite Gray



RAL 9010 Pure White



RAL 6009 Spruce Green



RAL 3009 Country Red



RAL 8011 Walnut Brown



RAL 9001 Natural White

Other colors available on special request.



Thermory Vivid Opaque thermo-spruce cladding.
Holiday Houses in Netherlands
Distribution & Photography by InterFaca

VIVID SILVERED

The look of weathered wood for decades.



If you like the **look of weathered wood**, Vivid Silvered is perfect for you. Thermally modified pine or spruce is brushed and repainted with either a light or dark silver-gray color.

Over time, the wood under the coating becomes visible as the paint wears off, eventually turning gray. Vivid Silvered doesn't require any specific maintenance – it just needs to be cleaned every few years.

VIVID SILVERED IS AVAILABLE IN COLOR OPTIONS:



Dark Silvered



Light Silvered



EXTREMELY LOW MAINTENANCE

Enjoy the weathered look for decades with no further coating needed

Vivid Silvered Dark and Light Gray products tonal choices are never identical. Each piece of wood absorbs the translucent paint layers differently due to the differences in the wood fibre arrangement, resulting in each board having a different gray tone variation.

VIVID TRANSLUCENT

Sophisticated cladding, dark yet natural.



Vivid Translucent cladding boards are coated with a translucent color that allows the wood's gorgeous natural pattern to shine through. The maintenance interval for Vivid Translucent products is 7 years.

Vivid Translucent products tonal choices are never identical. Each piece of wood absorbs the translucent paint layers differently due to the differences in the wood fibre arrangement, resulting in differing Vivid semi-translucent tones.

VIVID TRANSLUCENT IS AVAILABLE IN COLOR OPTIONS:



Black





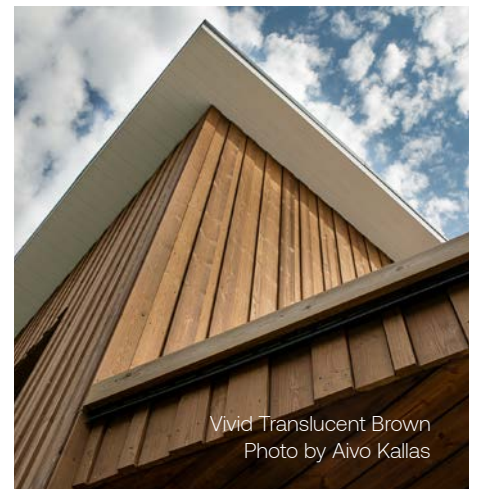



Brown

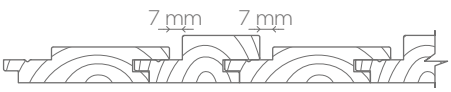
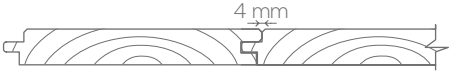
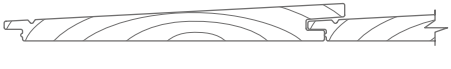
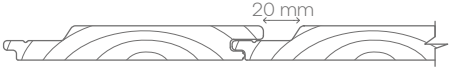
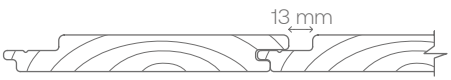

Vivid Translucent Brown
Photo by Aivo Kallas

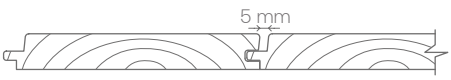
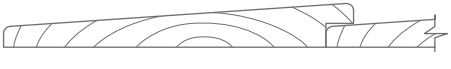
○ Standard items

PROFILE	WOOD SPECIES	MODIFICATIONS	FINISHING	THICKNESS (MM)	WIDTH (MM)	COVERING WIDTH (MM)	PCS IN BUNDLE
HIDDEN INSTALLATION: *PaCS CLAD 65-0 / **PaCS CLAD 65, 1 pc per square meter							
C7J 	Thermopine	Intense thermo, brushing, end-matching	Vivid Silvered / Translucent / Opaque	20	65	64*	8
				26	65	71**	6
*INSTALLATION: screws, nails or staples **HIDDEN INSTALLATION: Dekora clip, 2 pcs/ 1 m							
C8D 	Thermopine	Intense thermo, brushing, end-matching	Vivid Silvered / Translucent / Opaque	26	140	119*	3
						121**	
HIDDEN INSTALLATION: screws, nails or staples							
C34 Mix & Match 	Thermopine	Intense thermo, brushing	Vivid Silvered / Translucent / Opaque	20	90	71	4
				20	115	96	4
				20	140	121	4
				26	68	49	6
				26	115	96	3
				42	68	49	4
C15 		Intense thermo, brushing, end-matching		20	186	175	4
C11-S 	Thermospruce	Intense thermo, brushing	Vivid Silvered / Translucent / Opaque	21/12	185	165	4
C26 		Intense thermo, brushing, end-matching		19	141	125	4
				19	186	169	4
C25 	Thermoradiata pine	Intense thermo, brushing		20	138	121	4
				20	185	168	4
INSTALLATION: screws, nails or staples							
C7 	Thermopine			20	67	67	8
				26	68	68	6
C24 		Intense thermo, brushing, end-matching	Vivid Silvered / Translucent / Opaque	20	140	131	4
C2-R4 	Thermospruce			21/12	190	175	4
C4B 				20	211	211	4
				20	140	140	4
				20	68	68	8

PLEASE NOTE: Panel ends and any dents must be painted.

For installation procedures and requirements please follow [Thermory Cladding Installation Guide](#).
See also installation videos on Thermory Youtube channel.

All pictures are for illustrative purposes only. Actual products may differ in appearance as wood is a natural material - each piece is unique, just like us.



Thermory Vivid Opaque C34 Mix&Match thermo-pine cladding
Private house in Estonia. Photo by Terje Ugandi.



Thermory Vivid Opaque C34 Mix&Match thermo-pine cladding
Private house in Estonia. Photo by Terje Ugandi.



Thermory Vivid Opaque Black (RAL9005) thermo-spruce cladding in Belgium.
Photo by Thijs Jaspert

7. Corner profile

One universal profile for external and internal corners.

Boards with straight-cut ends can be installed without exposing the end-grain.



The easiest option for a seamless transition from wall to wall.



Standard selection available by pack. For the rest of products minimum order quantity applies.



Corner profile: CP3
Painted on site

○ Standard items

PROFILE	WOOD SPECIES	MODIFICATIONS	THICKNESS (MM)	WIDTH (MM)	FINISHING OPTIONS	PCS IN BUNDLE
INSTALLATION: screws or nails CP3 	Thermo-spruce	Intense thermo ○	42	42	Natural, to be finished on site	1

Sold according to order.

8. Roofing

PROFILE	WOOD	MODIFICATIONS	THICKNESS (MM)	WIDTH (MM)	COVERING WIDTH (MM)	PCS IN BUNDLE
INSTALLATION: screws or nails C10 	Thermo-pine	Intense thermo	20	140	110	4

All pictures are for illustrative purposes only. Actual products may differ in appearance as wood is a natural material - each piece is unique, just like us.

9. Additional information

9.1 BOARD LENGTHS

- Thermory board length depends on wood species, length step is always 300 mm.
 - Allow for 10 percent wastage when purchasing cladding products.
 - Thermory thermo-ash is generally produced in length range 1200-4800 mm.
 - Thermory thermo-pine and thermo-spruce length range is 3000-6000 mm.
 - Thermory thermo-radiata pine is produced in length range 3000-6000 mm.
 - All PaCS cladding boards such as C7J, C4J, C23J are limited to maximum length 4800mm.
 - Maximum length for Joint End Matching is 5400 mm. End matched ash boards are 20 mm and softwood boards 50 mm shorter.
- Please check availability of specific lengths of interest from our sales team info@thermory.com.

9.2 SURFACE TEXTURES



BRUSHING

Some of Thermory's finished cladding products **come with a brushed surface as standard.** Brushing beautifully highlights the wood's natural grain.



ROUGHENING

If desired, it is possible to order Thermory thermo-pine cladding **with a Scandinavian roughened look.** This gives the boards a distinctive rustic appearance with smooth refined furrows.



EMBOSSING

Embossing is a novelty technique that we offer for some of our products. It is a non-chemical treatment that gives a beautiful structure to the wood without changing its properties.



9.3 STORAGE

- Whenever possible, Thermory cladding boards should be stored indoors. The cladding should also be kept away from direct sunlight as UV rays will cause the color of the boards to fade. If stored outside, the boards should be elevated at least 150 mm from the ground, stacked evenly, and protected with a waterproof, light-impermeable cover. Leave the ends of the cover unfastened to allow for ventilation while still preventing moisture damage. Thermory cladding should never be left in the rain or exposed to excess moisture while in its original packaging, as it will not be able to dry properly when tightly packaged.
- When restacking painted cladding products at the work site, do not remove the protective foil from between the front-facing sides of the cladding, as the boards should not be stacked with the painted surfaces touching each other without a foil layer in between.
- Cladding products for indoor uses must be stored in a heated indoor space for a few weeks prior to installation.
- Handle Thermory boards with care. The tongue-and-groove sections of boards may be fragile.

9.4 INSTALLATION

For installation procedures and requirements please follow Thermory Cladding Installation Guide.

When fixing boards using staples, nails or screws, we recommend using Thermory Benchmark thermo-spruce with a Class 1 biological durability rating for the battens. Battens must be placed no more than 600 mm apart and be at least 25 mm thick in order to create a sufficient gap behind the cladding boards for ventilation.

Fix horizontal cladding boards onto vertical battens and vertical cladding boards onto horizontal battens, in both cases with the ends resting on the battens for boards without end-matching. Joint end-matched boards can be placed with the joints meeting between the battens; this will save both material and time

WATCH THE INSTALLATION VIDEOS ON THERMORY YOUTUBE CHANNEL



THERMORY CLADDING PROFILES FOR HORIZONTAL INSTALLATION: C2R4, C6, C7J, C7T, C8D, C9, C11, C23J, C44J, C92, G-C77J, S1, S2-BBME, S2-BBMS, S2-E

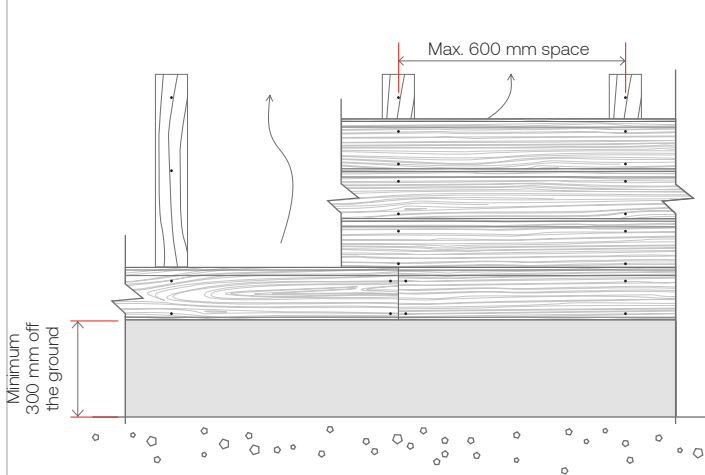

THERMORY CLADDING PROFILES FOR VERTICAL INSTALLATION: C12, C27, C34, C34-2, CP3, D43, UYS10

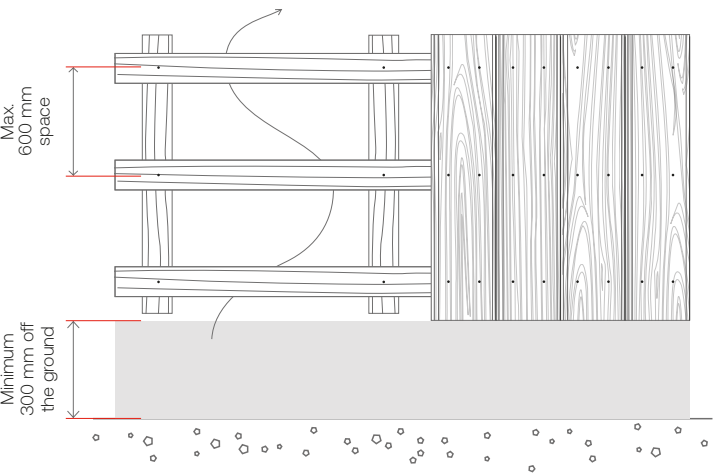

THERMORY CLADDING PROFILES FOR BOTH VERTICAL AND HORIZONTAL INSTALLATION: C1, C3, C4, C4J, C7, C8, C15, C16, C19, C20, C24, C25, C26, C30, C32, C42, CAR1, CAR3, CAR8, CAR12



Uncoiled Thermory Benchmark thermo-pine cladding few years after installation. The Waterfront, residential development in Stavanger, Norway. Designed by AART Architects.

9.5 MAINTENANCE

For maintenance and care requirements please follow **Thermory Cladding Maintenance Guide**.

- Thermally modified wood does not necessarily need surface treatment. Like any other wood, the surface of Thermory products naturally turns gray over time. This process starts immediately after the products are installed and takes anything from a few months to a few years, depending on the intensity of UV radiation and rain. Sapwood within a board turns dark gray faster than heartwood.

- In order to reduce the natural silvering process, Thermory boards can be protected by coating them with a UV-resistant pigmented mineral oil. The use of organic oils is not recommended outdoors or in damp rooms, as they contain substances that provide a source of nutrition for biological organisms, such as bacteria, mold, etc.

- For Thermory coated claddings, maintenance painting requirements are based on the specific product.

- Keep in mind that wood is a natural material and so any color changes may be uneven. Each board ages in its own way, and different sides of a building's facade will also age differently depending on the sun and rain they're exposed to.



Thermory Benchmark thermo-pine cladding few months after installation. The Waterfront, residential development in Stavanger, Norway. Designed by AART Architects

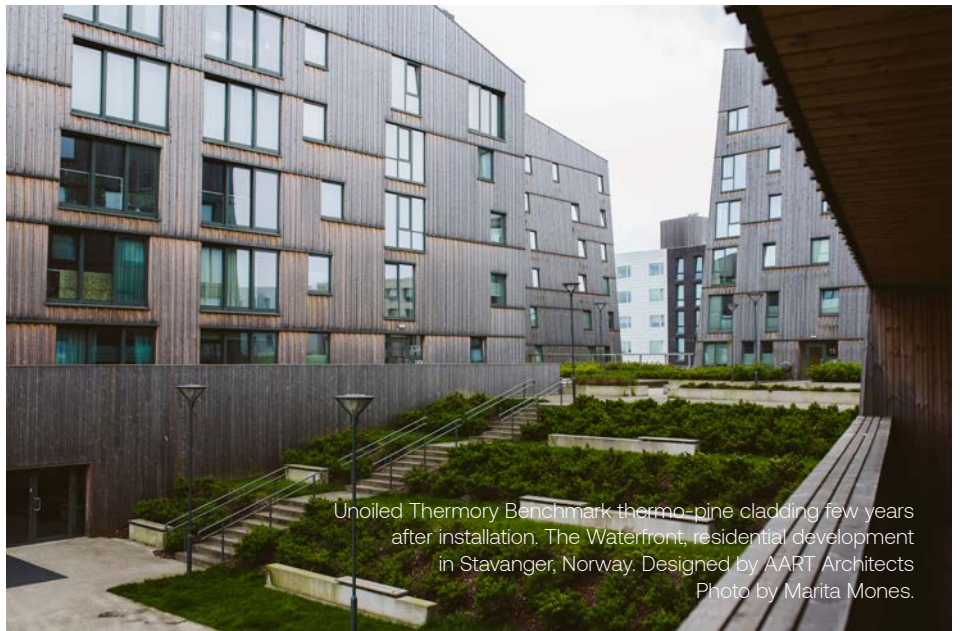

Unoilied Thermory Benchmark thermo-pine cladding few years after installation. The Waterfront, residential development in Stavanger, Norway. Designed by AART Architects
Photo by Marita Mones.

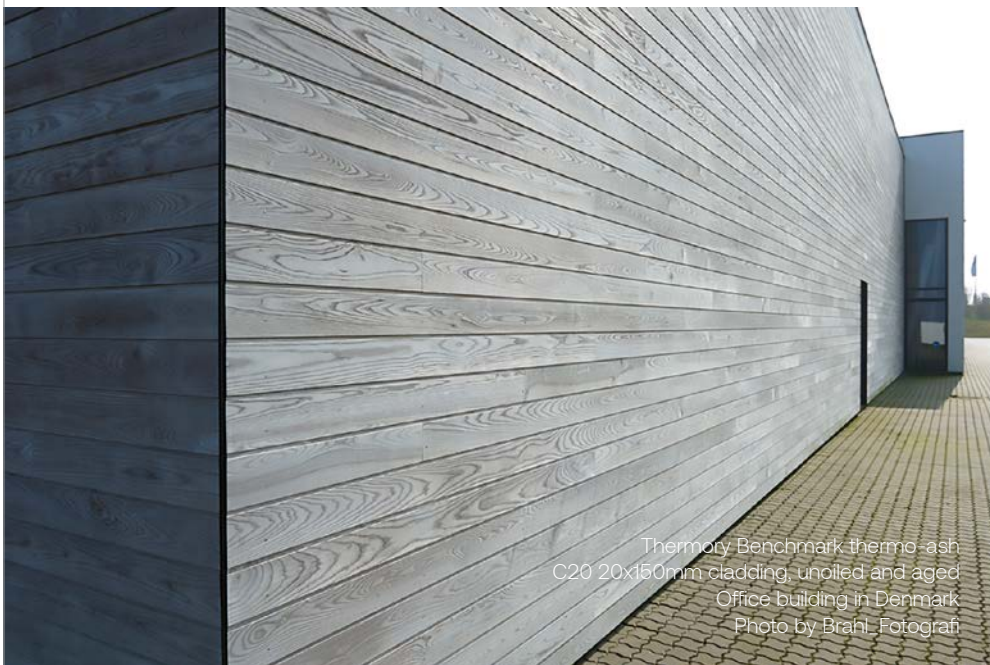

Thermory Benchmark thermo-ash C20 20x150mm cladding, unoilied and aged
Office building in Denmark
Photo by Brahl Fotograf





Leave a lasting impact

THERMORY is a world leader in the thermal modification of wood. We offer high-quality, long-lasting solutions that benefit from environmentally friendly technology. We have spent the past two decades developing our expertise through close collaboration with architects, designers, builders and homeowners – constantly revising our product selection and refining our technology in the process.

THERMORY promotes a transparent and responsible corporate culture. We care about the environment and treat nature with deep respect. Our purchasing process is environmentally responsible, and we exercise high standards for quality and sustainability. Our timber is carefully inspected and harvested from sustainably managed forests. If desired, we can offer PEFC, FSC or Nordic Swan Ecolabel-certified wood.



As a renewable resource that is both durable and an excellent insulator, wood is one of the most

- Thermory
- Thermory
- Thermorydesign
- Thermory AS

→ thermory.com

environmentally friendly choices for your construction projects. If you think it's important to protect our valuable resources long into the future, then we're on the same mission. We create lasting value, because we want to leave behind a more harmonious and sustainable world.

REAL WOOD PRODUCTS WITH BEAUTY AND STABILITY IN EVERY FIBER

- DECKING
- CLADDING
- INTERIOR
- SAUNA



Thermory's project 'Development of Resource-efficient Painted Thermally-modified Wood' is financed in cooperation with Enterprise Estonia (EAS) and the Norwegian Green ICT financing mechanism.

